

# **TOPEKA METRO BUS STOP GUIDELINES**



*Adopted by Topeka Metro  
Board of Directors  
May 21<sup>st</sup>, 2018  
Topeka, Kansas*

## Introduction

Bus stops are key points of contact between the public and the Topeka Metro bus system. Assuring that stops are good ambassadors for Topeka Metro is of primary importance for attracting and keeping riders. Defining consistent standards for stops helps Topeka Metro integrate with the community and makes Topeka a better place to live. The safety and accessibility standards outlined in this guide make stops more easily recognized and match stop amenities with stop use. While not all stops can be made to match these guidelines due to environmental and budgetary constraints, these guidelines define the goals Topeka Metro has for improving standards for new and redeveloped stops.

These guidelines were developed to provide suggested design features, placement, and amenities of bus stops within the Topeka Metro system. These guidelines are not to be used as specific standards, but only as guidance when designs are being developed for new or relocated stops and for upgrades to existing stops and related facilities. Many factors should be considered in addition to these guidelines, including, but not limited to, the use of engineering judgement, the evaluation of real-world locational data such as land use, equity concerns, adjacent land owner preferences, area topography, and available public right-of-way.



*8th Street at Harrison Street*

This document provides design guidelines to be used in conjunction with Topeka pedestrian and street design policies, Complete Street policies and guidelines, and land-use ordinances when developing Topeka Metro passenger access areas. These guidelines can be useful for developers interested in facilitating access to the bus system in their projects. This document may also be helpful to members of the public seeking to understand the considerations for placement of bus stops and the amenities at those stops. While these guidelines incorporate requirements of the Americans with Disabilities Act (ADA) and federal and Kansas mandates, designers should be familiar with controlling regulations and assure their facilities are compliant with any applicable rules. An outline of the process used when evaluating bus stops for potential upgrades can be found in Appendix A.

## Bus Stop Design

Bus stop design seeks to improve bus passengers' experiences by providing an easily identified area that is a safe, accessible, and comfortable place to wait for, board, and disembark from Topeka Metro buses. Stop design also seeks to minimize the negative impact on traffic flow for other vehicular traffic, minimize the impact on available parking, and scale the cost of developing stops to match the characteristics and needs of each stop. The goal is to have all bus stops include a paved, accessible area and identifiable signage. Additional amenities are considered for stops meeting development criteria or serving populations with special needs. Characteristics included in stop criteria include:



*Topeka and Shawnee County Library*

- » number of riders using a stop
- » land use adjacent to the stop
- » high-density housing nearby
- » school nearby
- » medical facilities nearby
- » recreational opportunities nearby
- » roadway traffic volume and speed
- » transfers between bus routes
- » slope of the land
- » limited access/right-of-way

# Stop Location

Stops can be located before an intersection (near-side), after an intersection (far-side), or, in special circumstances, in the middle of a block (mid-block). Selecting where a stop is placed involves the evaluation of passenger destinations, traffic flows (including driveways and turning lanes), and pedestrian safety. Some advantages and disadvantages of each location are listed in Table 1.

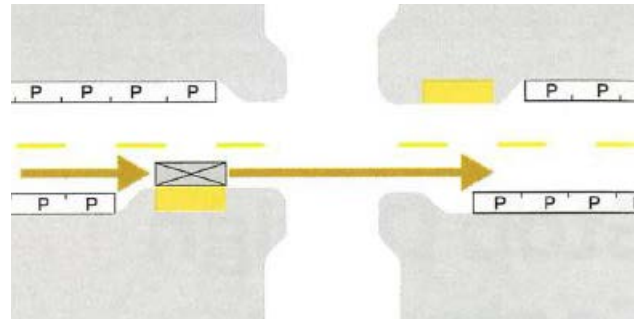

Figure 1 - Near-Side Bus Stop Location (NACTO)

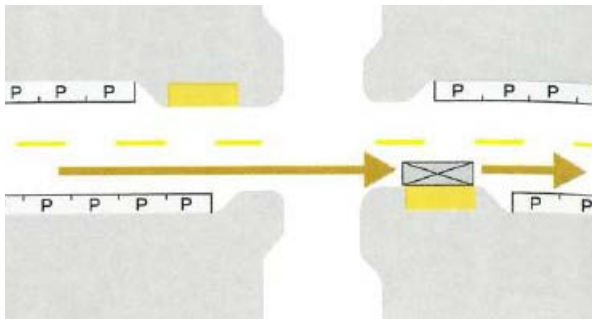

Figure 2 - Far-Side Bus Stop Location (NACTO)

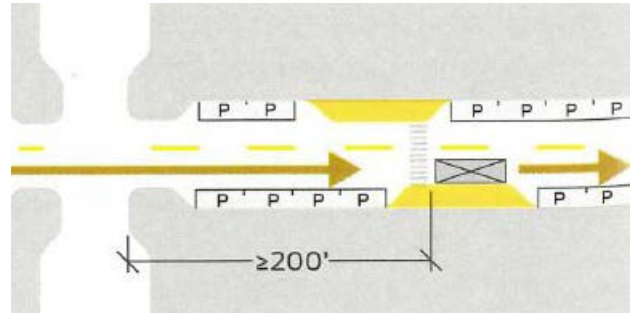

Figure 3 - Mid-Block Bus Stop Location (NACTO)

Far-side Stop	Near-side Stop	Midblock Stop
<p><b>Advantages</b></p> <ul style="list-style-type: none"> <li>Minimizes conflicts with right-turning vehicles.</li> <li>Minimizes sightline conflicts on approaches to the intersection.</li> <li>Encourages pedestrians to cross behind the bus.</li> <li>The intersection absorbs some of the space requirement for deceleration.</li> <li>The driver can pull back into the travel lane due to the gap in traffic created by the signal</li> <li>Optimal location for Transit Signal Priority (TSP) because vehicles can move through the intersection without stopping</li> </ul>	<p><b>Advantages</b></p> <ul style="list-style-type: none"> <li>Minimizes interference when traffic is heavy on the far side of the intersection.</li> <li>Passengers access the bus closest to the crosswalk, and while stopped at a red light.</li> <li>The bus can use the intersection for acceleration space.</li> <li>Avoids the potential for double stopping for the signal and passenger movements.</li> <li>The driver is provided with a full view of the intersection.</li> <li>Passengers can transfer without crossing the street if a perpendicular route has a far-side stop.</li> </ul>	<p><b>Advantages</b></p> <ul style="list-style-type: none"> <li>Minimizes sight line issues for pedestrians and drivers.</li> <li>Minimized conflict with vehicular traffic at intersections.</li> <li>The waiting area can be more spacious and less congested because the stop is located away from busy intersections.</li> <li>Can be located close to major trip generators.</li> <li>Adjacent driveways could be used to add pull-in and pull-out space.</li> </ul>
<p><b>Disadvantages</b></p> <ul style="list-style-type: none"> <li>Traffic conflicts may occur if the bus is unable to clear the intersection.</li> <li>Sight distance may be limited for crossing vehicles and crossing pedestrians.</li> <li>May result in double stops (once for a red signal and once for passenger access).</li> <li>May increase rear-end accidents if drivers do not expect bus is stopping beyond the intersection (increased risk if bus double stops)</li> </ul>	<p><b>Disadvantages</b></p> <ul style="list-style-type: none"> <li>Increases conflicts with right-turning vehicles.</li> <li>The bus can obscure curbside traffic control devices.</li> <li>The bus can obscure pedestrians crossing.</li> <li>Crossing pedestrian sight lines are obstructed.</li> <li>Multiple buses may block the travel lane during peak hours.</li> <li>Potential for conflict between pedestrians crossing the intersection and passengers waiting to board the bus.</li> </ul>	<p><b>Disadvantages</b></p> <ul style="list-style-type: none"> <li>Pedestrian safety concerns if a midblock crosswalk is not provided (encourages jaywalking).</li> <li>Increased walking distance for passengers needing to cross at an intersection.</li> <li>Requires more space for the bus to accelerate and decelerate.</li> <li>Reduces on-street parking availability because the stop requires a longer bus zone.</li> </ul>

Table 1 - Stop Location Advantages and Disadvantages



# Typical Stop Configurations

There are four types of stop configurations applicable to Topeka Metro’s service area.

- **Curbside Stop** – Most Topeka Metro stops are designed for the bus to pull to the curb in a traffic lane or in a parking-restricted lane to pick up and drop off passengers. In-traffic curbside stops minimize dwell time and are the least expensive to implement and move since existing roadway is being used. In-traffic curbside stops are best used in lower traffic areas with speed limits under 40 mph. Since a traffic lane is blocked for the duration of boarding, this stop type negatively impacts other vehicular traffic.



Curbside Stop, Indiana Avenue at 32nd Street



Figure 4 - Curbside Stop (Gold Coast Transit)

- **Curb Extension Stop (Bus Bulb)** – This configuration is used to allow a bus to stop in the traffic lane where there is on-street parking. By extending the curb to the edge of the traffic lane, pedestrians can board and exit the bus from the stop without crossing parking spaces. Dwell time is reduced, since the bus remains in the traffic lane. The extension allows for more space for stop amenities or landscaping.

*Where dedicated bike lanes are provided, a curb extension can be combined with a bike lane path deviation to avoid buses crossing the bike lane to reach bus stops. Bike lanes can be raised to the height of the stop platform to improve accessibility for bus riders between the sidewalk and bus platform. The bike lane should be differentiated from the platform and sidewalk by using contrasting coloration and bus passenger crosswalks should be painted across the bike lane.*

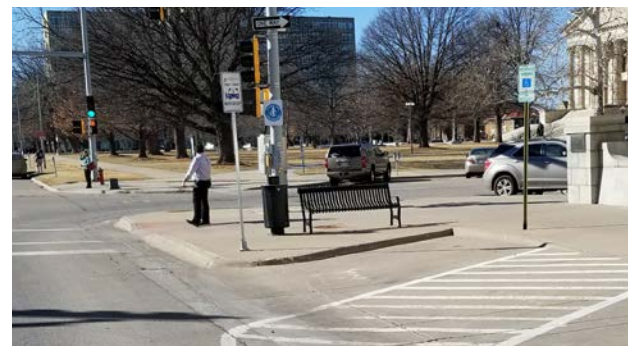

Curb Extension, 10th Street at Jackson Street

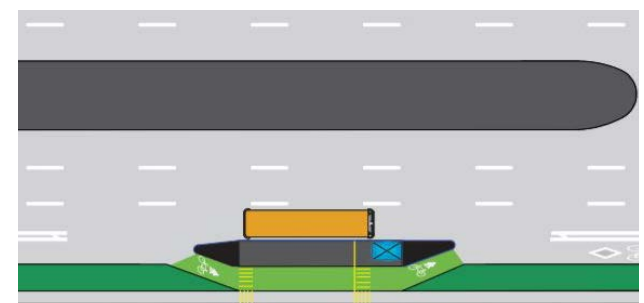

Figure 5 - Curb Extension With Bike Lane (City of Winnipeg)

- **Pull-out (Bus Bay)** – Pull-outs are built into the side of the roadway and allow the bus

to exit the traffic lane for passenger boarding and exiting. A pull-out stop allows other traffic to proceed without impediment, particularly beneficial for stops with high ridership or where many passengers have limited mobility. Reentering traffic may be challenging, increasing overall transit time. Constructing pull-out stops is costly and can reduce space for sidewalks. These stops are best used on higher speed roads and those where a bus stopped in the traffic lane would reduce needed sight distances.



Pull-out Stop, 29th Street at Gage Boulevard

- **Median Stop** – A median stop is to the left of all traffic lanes. Similar to a pull-out, this type of stop allows a bus to stop outside of traffic lanes, with passengers using a dedicated island for bus access. The island could be used to allow passengers access to destinations on the left-hand side of a one-way street without crossing regular traffic lanes.



Figure 6 - Pull Out Stop (Pace Suburban Bus)



Figure 7 - Median Stop (NACTO)

## Bus Stop Accessibility

The Americans with Disabilities Act (ADA) act of 1990 was intended to make American society more accessible to people with disabilities. Two of the five sections within the ADA guidelines, public services and public accommodations, affect bus stop planning, design, and construction. Figure 8 illustrates the ADA requirements for bus stops. While new stops must conform to ADA physical dimensions, there is not a requirement that existing stops be modified to become compliant.

ADA compliance focuses on providing accessibility from the point of origin to the final destination. General design considerations involve obstacles, surfaces, signs, and telephone poles. The Transportation Research Board publishes [useful guidelines for ADA compliance at bus stops](#).

Surfaces must be stable, firm, and slip-resistant. It is recommended to avoid abrupt changes in



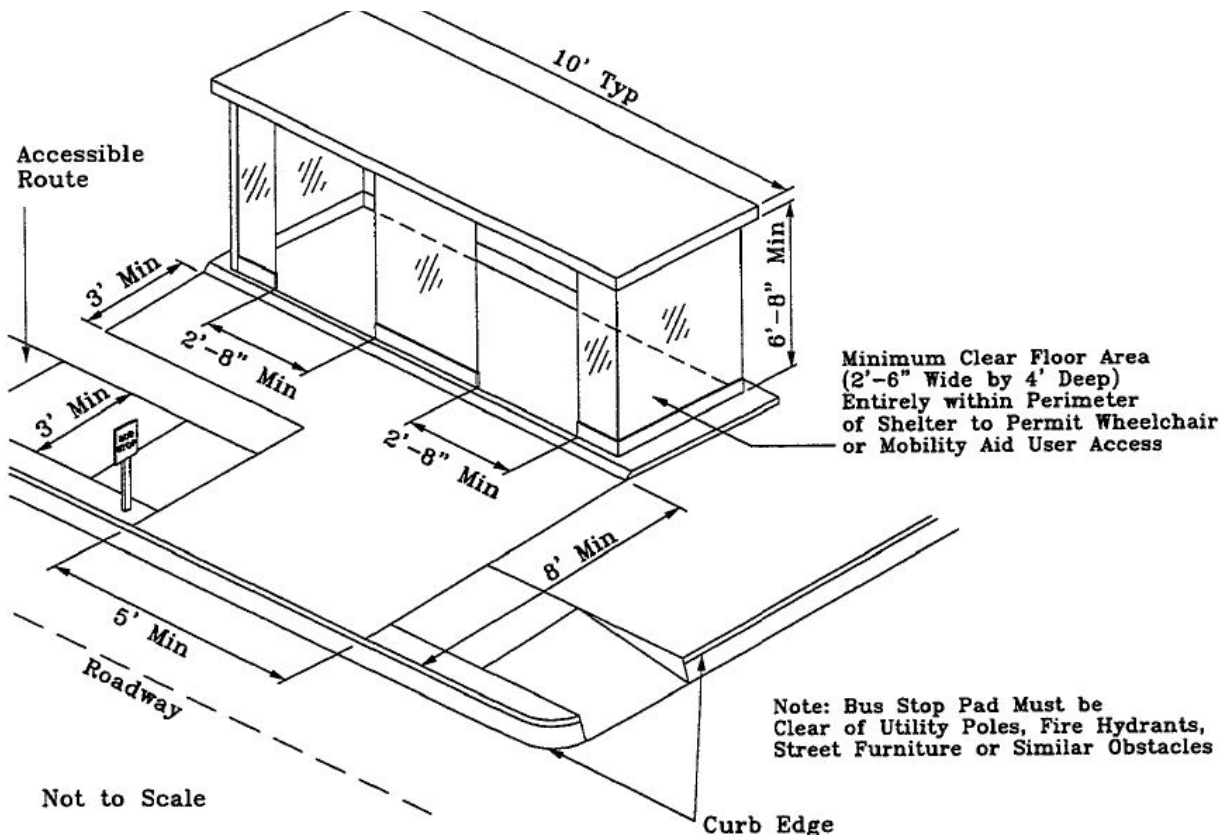
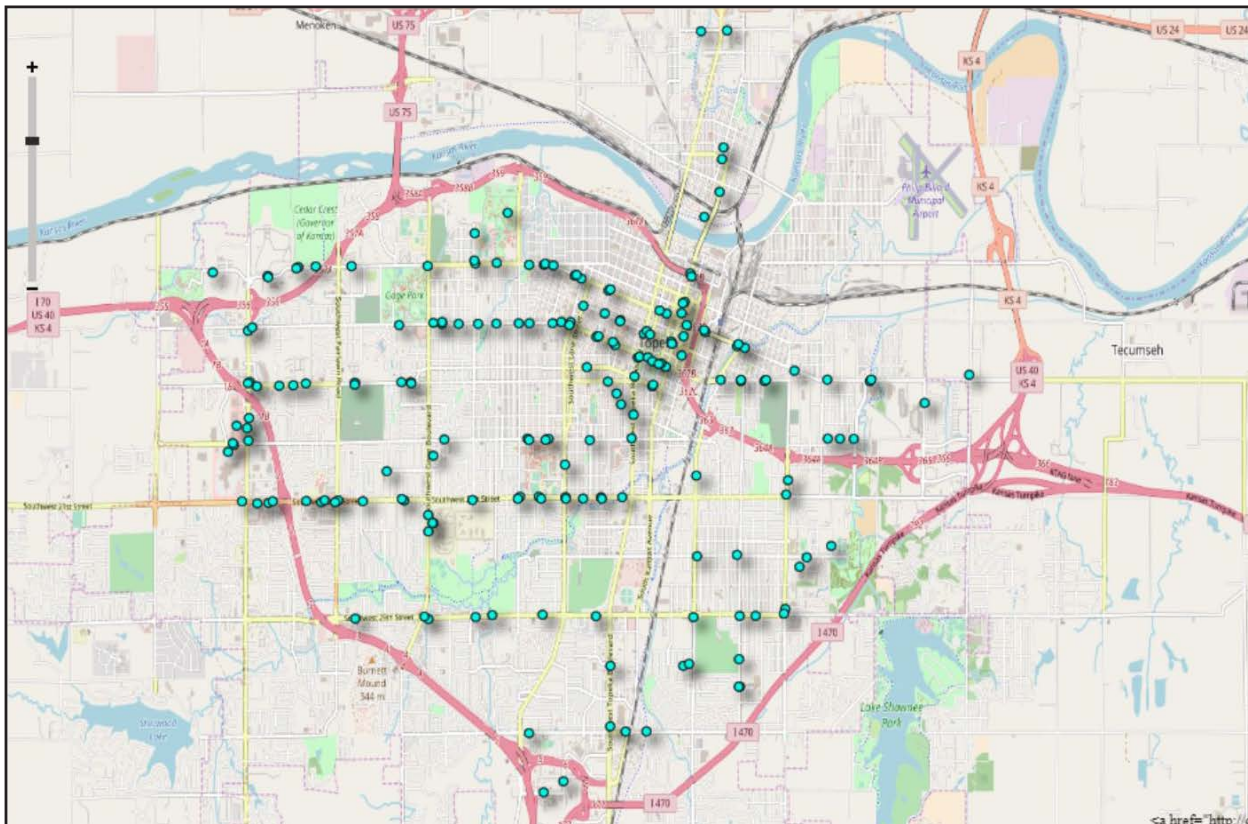

Figure 8 - Accessible Bus Stop Minimum Dimensions, Transportation Research Board, TCRP 19 Guidelines

Map 1 - ADA Compliant Stops, April, 2018



grade, and bevel those that cannot be eliminated. Any drop greater than 1/2 inch or a surface grade steeper than 1:20 requires a ramp.

Signs providing route designations, bus numbers, destinations, and access information must be designed for use by transit riders with vision impairments. Specific guidelines are given for these signs in Section 4.30 of the [ADA Accessibility Guidelines](#) published by the United States Access Board.

Obstacles higher than 72 inches and lower than 80 inches should be moved or removed, as a person with vision impairment may not be able to detect this obstacle. It is recommended that any obstacles with this height range should be moved or removed along the entire path, as it may make it inaccessible for some transit users with disabilities.

ADA compliance for all stops is an important goal of Topeka Metro. In pursuit of that goal, numerous grants have been secured to improve bus stops. These improvements have proceeded route-by-route, with each subsequent route chosen to upgrade the maximum number of stops lacking ADA compliance. Map 1 shows the ADA compliant stops as of April 2018. All routes will see amenity improvements in 2018 with a focus on routes #1 Oakland, # 12 Huntoon, and #29 West 29th Street, which currently have the lowest percentage of ADA-compliant stops. Topeka Metro is working aggressively to improve bus stops in all areas of Topeka.

## Bus Stop Amenities

### Signage

Each stop is required to have a sign identifying it as a Topeka Metro Bus Stop. This sign should be attached to a dedicated pole when such placement does not restrict the view of other important signage at the site. The pole should be placed a minimum of 2' from the edge of the curb at the downstream end of the stop (furthest along the direction of travel). The sign should not infringe on the accessway to the ADA landing pad, and should be at least 2' from the sidewalk. The bottom of the sign should be between 84" and

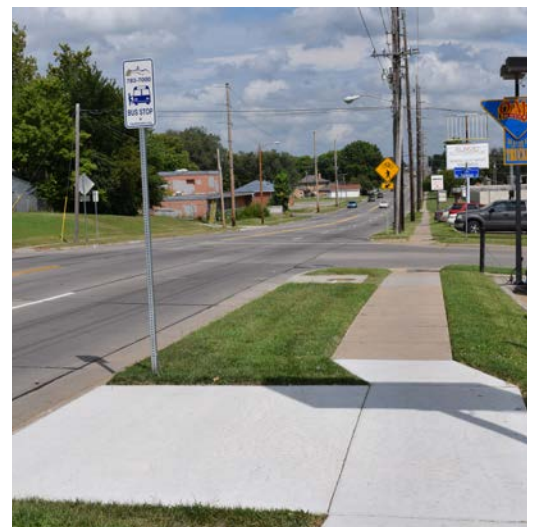

21st Street at Buchanan Street



96” above the surface of the stop, and should be easily visible to an approaching bus operator.

Wayfinding or route information signs should be placed at all major stops either on the bus stop sign pole or attached to a bus shelter. These informational signs should be placed no higher than 60” above grade.

### **ADA Landing Pads**

All stops should have an ADA compliant landing pad at least 5’ wide measured parallel to the curb and 8’ deep measured perpendicular to the curb. Concrete is the preferred material for this pad. The pad area should be clear of all obstructions and should be connected to the sidewalk by a paved area at least 4’ wide. The slope of the landing pad should match the roadway slope, not exceeding a 2% slope. Connections between the stop and adjacent sidewalks should not exceed an 8% slope.



*8th Street at Clay Street*

### **Benches**

Topeka Metro uses a standardized bench measuring 60” by 30”. The front of the bench should be at least 3’ from the street. In cases where the traffic lane is directly adjacent to the curb or where traffic speeds exceed 30 mph, the setback should be increased to enhance passenger safety and comfort. Benches should be oriented to face towards the approaching buses or towards the street to help make waiting passengers visible to bus operators. Benches should be placed on concrete pads with at least 3’ of circulation space between the bench and other pedestrian impediments (signs, fire hydrants, utility poles, etc.) If located adjacent to an existing wall or building, the back of the bench may be placed a minimum of 1’ from the wall or building. Benches should not be placed in a way that obstructs pedestrian flow along a sidewalk or other walkway. Benches and trash receptacles are usually placed together at stops.



*21st Street at Washburn Avenue, Topeka Metro*

## **Shelters**

Where passenger boardings or other conditions indicate, shelters may be placed to increase comfort for waiting passengers. Shelters should be placed on a concrete pad with at least 3' of circulation space between the shelter and other pedestrian impediments. The size, location, and orientation will vary depending on space availability. The standard minimum sized shelter that is accessible is 5' by 10', with a minimum clear floor area of 3' by 4'. A clear path should be available for a wheelchair user to enter from the public way. To avoid impeding sightlines, shelters should be placed outside the sight triangle (see Figure 9). Shelters are usually oriented parallel to the street, at the extreme downstream end of the pad, and with a minimum 8' setback from the curb at the closest point. When possible, bus stop information is provided on the shelter. Trash receptacles are placed at all stops with shelters.



*12th Street at Buchanan Street*

## **Lighting**

All stops within the Topeka Metro system are served after sunset during the winter months, so ensuring adequate lighting at the site is important to passenger comfort and security. Existing lighting may be adequate, but stops should be evaluated for consideration of additional lighting. Additional lighting can be either solar lighting installed inside shelters or pole mounted solar lights at stops where shelters are not installed. It may benefit both Topeka Metro and any adjacent business owner to explore having the business enhance their exterior lighting near the stop.



*Pole Light, 10th St. at Highland Avenue*

## **Trash Receptacles**

Maintenance of trash receptacles incurs significant ongoing operating expenses, so the decision to include a receptacle at a stop should be considered carefully. Trash receptacles should be placed at all stops which have shelters, since these stops are already visited weekly by maintenance personnel. Where trash receptacles are placed, they must not infringe on the ADA compliant landing pad or obstruct access from the sidewalk or passenger waiting areas to the boarding area.

## ***Bike Racks***

Bike racks improve the possibility of multi-modal commutes. All bike racks at Topeka Metro stops are designated as Topeka Metro Bike (TMB) bikeshare hubs, allowing TMB bikes to be returned at any of these racks. By providing a secure alternative in the case that all bike racks mounted on a bus are full, racks also encourage multi-modal commuting with passengers' own bikes. Racks can also enhance the ability of bus riders to access recreational facilities. Racks are inexpensive and require little maintenance, so should be considered for stops in proximity to commuter traffic generators and recreational facilities such as trails. Racks should be mounted on concrete pads and placed where they do not obstruct access to sidewalks, boarding areas, or other stop amenities. Racks should be located in public view with good lighting to improve security.



*21st Street at McAlister Avenue*

## ***Choosing Amenities***

The choice of amenities placed at a particular stop is based on many variables and the number of passengers boarding is always a consideration. The following chart provides general guidelines based on daily boardings, but every stop has a unique set of environmental factors and passenger profiles often resulting in variations from these guidelines. A brief discussion of complicating factors impacting placement of stops as well as amenities included at a stop follows the Bus Stop Classification and Recommended Amenities chart. Map 2 shows weekly boardings for stops within the Topeka Metro system.



<b>Bus Stop Classification and Recommended Amenities</b>			
	<b>100+ Weekly Boardings</b>	<b>25-99 Weekly Boardings</b>	<b>&lt;25 Weekly Boardings</b>
<b>Bus Stop Sign</b>	<b>X</b>	<b>X</b>	<b>X</b>
<b>Standing Pad - 5' x 8' minimum</b>	<b>X</b>	<b>X</b>	<b>X</b>
<b>Bench</b>	<b>X</b>	<b>X</b>	
<b>Trash Receptacle</b>	<b>X</b>	<b>X</b>	
<b>Route map</b>	<b>X</b>	<b>X</b>	
<b>Shelter</b>	<b>X</b>		
<b>Lighting</b>	<b>a.</b>	<b>a.</b>	<b>a.</b>
<b>Bike Rack</b>	<b>b.</b>	<b>b.</b>	<b>b.</b>
<i>a. Additional lighting need is evaluated based on existing lighting conditions.</i>			
<i>b. Bike rack need is evaluated based on local conditions, e.g. proximity to trails, commuter needs, passenger boardings.</i>			

Map 2 - Weekly Passenger Boardings at Stops

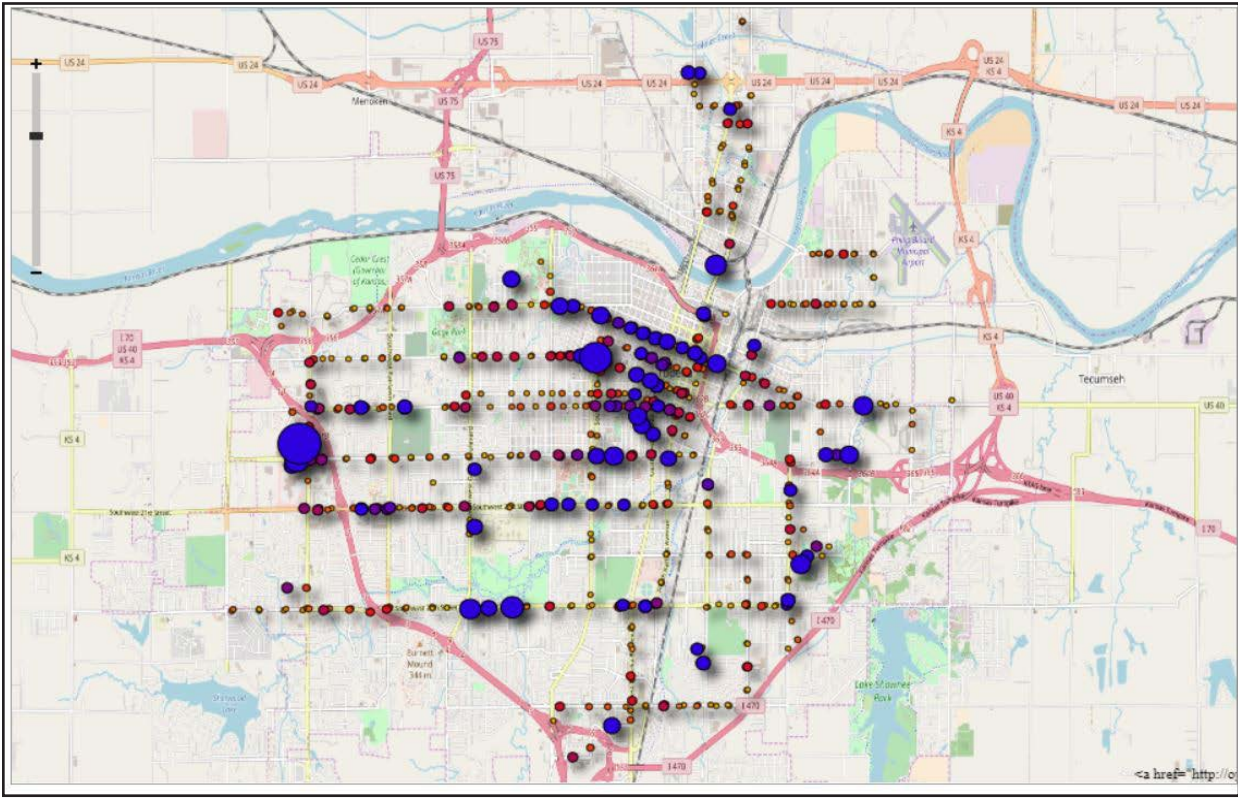

Weekly Boardings 0-49 50-99 >100

## Sight Distance Triangle

The City of Topeka has established a 40' sight distance triangle regulation as illustrated in Figure 9. At a minimum, no bus stop amenities will be placed within the area represented by the shaded triangle. Site specific conditions (e.g. traffic speed, high numbers of turning cars) may encourage more conservative placement allowing for better sight lines.

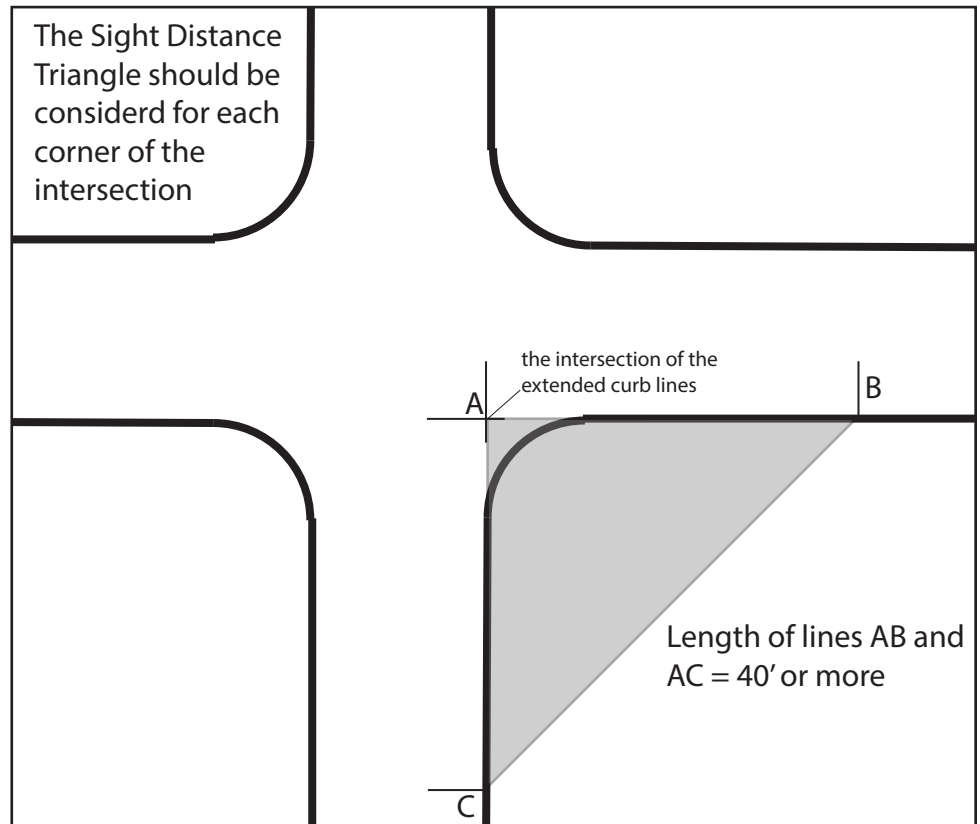

Figure 9 - Sight Distance Triangle

## Complicating Factors for Stop Placement

Nothing in these guidelines should be used in the absence of common sense, an understanding of the populations being served, and knowledge of the “on-the-ground” realities of the environment in which Topeka Metro buses operate. The following considerations can sometimes be the controlling factors for stop placement.

### Land Use

Consideration should be given to how property adjacent to a potential stop location is being used. Placing a stop in the right-of-way in front of a single-family house may be less satisfactory than moving the stop to an area in front of a business that would welcome the additional traffic that a bus stop generates.

## **Property Owner Preference**

Land owners, particularly in residential areas, may oppose the location of bus stops adjacent to their property. Even when there is a legal right to place a stop on public right-of-way, the opposition of a resident or group of residents can make choosing a location other than what might be considered optimal from a purely data-driven perspective the best choice. This is particularly true in lower density areas where daily boardings are low.

## **Site Topography**

In areas with significant elevation changes, it can be very difficult to meet design guidelines. Steep slopes adjacent to the roadway can require lengthy and expensive ramps and retaining walls between the sidewalks and stop landing pads. When cost effectiveness is considered, certain low-need, low-ridership stops may require relocation to an area with a less challenging topography. Locations in floodplains may raise similar concerns about cost effectiveness as well as considerations of the need for environmental approvals. The choice to locate stops to less topographically challenged sites must be balanced against reducing passenger convenience by adding walking distance to reach stops.



*21st Street at Topeka West High School, Google Maps*

Locations in floodplains may raise similar concerns about cost effectiveness as well as

considerations of the need for environmental approvals. The choice to locate stops to less topographically challenged sites must be balanced against reducing passenger convenience by adding walking distance to reach stops.



*10th Street & Carnahan Avenue, steep slope with existing fixed infrastructure*

## **Traffic Conflicts**

Certain roadways and intersections have traffic patterns that make commonly accepted solutions not the safest options for stop location and design. Bus operators, near-miss and accident reports can all be sources of information about risky areas that lead to increased risk for passengers waiting to board or exiting buses, pedestrians moving in areas around bus stops, and buses approaching and leaving stops.



## ***Existing Infrastructure***

Many components of urban infrastructure were installed in a time when less consideration was given to non-automotive transportation. Existing utility poles, drainage structures, trees, and sidewalks can all impede the ability to implement optimal bus stop design. Short of full reconstruction of a roadway, there is often little that can be done to allow for a bus stop to be built meeting all the guidelines in this document. A lack of infrastructure, such as a lack of sidewalks in an area, can derail the effort to make stops ADA compliant and are often outside the control of a transit organization. Streets in older areas of a town may be too narrow and have minimal right-of-way available to construct the best bus stop.

## ***Rider Demographics***

The makeup of riders close to a bus stop can often override other considerations when designing bus stops. Areas with a high percentage of elderly residents might advocate for additional seating and shelter. Stops close to service agencies may have a higher need for stop amenities than ridership numbers would indicate. Stops along lines servicing areas with hospitals may have similarly higher needs.

## **Conclusion**

Many situations encountered on real-world streets will not fit into the rules contained in this guide. By keeping the passengers in mind and by using common sense, reasonable solutions can be found for most bus stop challenges while maximizing the benefit to passengers of the limited resources available across the entire system.

# Appendix A - Process for Improving Bus Stops

## Introductory Steps

- Identify need: check ridership, adjacent land use, etc.
- Seek input from road supervisor
- Site review – City Engineering, Metro: planning, maintenance director, road supervisor
- Map potential sites(s)

## Obtain Input

- Bus operator/supervisor input
- Written notifications/permissions from adjacent property owners
- Written preliminary approval from City Engineering

## Prepare and Present Site Lists

- Final list of proposed site(s) – decide on amenities based on Bus Stop Guidelines
- Aerial views – prepare a file for submission to FTA
- Submit proposed site(s) to FTA for environmental approval
- Prepare site list for FTA and/or KDOT grant file
- Submit final site(s) to Engineer for surveying
- Written notification to City Development Services
- Final written approval from City Engineering
- Written notification to City Attorney

## Procurement Process

- Prepare pad construction RFP (PCRFP)
- Board approval for PCRFP
- Review and approve engineering study
- Order amenities as needed
- Publish PCRFP w/ engineering study
- Award PCRFP
- Small purchase procedure for an electrician as needed

## Construction and Installation

- Pad construction
- Davis-Bacon requirements reporting
- Install the amenities
- Electrical hookup as needed

## Grant Reimbursement

- Complete the FTA Grant site list, submit expenses for grant reimbursement

## References and Graphics Credits

City of Winnipeg, Pembina Highway Buffered Bike Lane Project, 2014

Gold Coast Transit, Bus Stop Guidelines, June 2015

NACTO - National Association of City Transportation Officials, Transit Street Design Guide, 2016

Pace Suburban Bus – Transit Supportive Guidelines, 2018

Transportation Research Board, Transit Cooperative Research Program, TCRP Report 19, Guidelines for the Location and Design of Bus Stops, 1996

United States Access Board, Accessibility Guidelines, 2002

All uncredited photographs and figures by Topeka Metro

